

---

## USER MANUAL

### Window Type

#### MAW

---

Frequency: 60Hz

Capacity: 5000 ~ 15000BTU/h

---

Warning notices: Before using this product, please read this manual carefully and keep it for future reference.

The design and specifications are subject to change without prior notice for product improvement. Consult with your dealer or the manufacturer for details.

---

**Safety Precautions ..... 3**

**Operating Instructions ..... 8**

**Installation Instructions ..... 19**

**Care and Cleaning ..... 20**

**Troubleshooting Tips ..... 24**

**Remote Control Instructions ..... 27**

**Warranty and Return Policy ..... 34**

**Read This Manual**

Inside you'll find many helpful hints on how to use and maintain your air conditioner properly. Just a little preventive care on your part can save you a great deal of time and money over the life of your air conditioner. You'll find many answers to common problems in the troubleshooting tips - you should be able to fix most of them quickly before calling service. These instructions may not cover every possible condition of use, so common sense and attention to safety is required when installing, operating and maintaining this product.



**CAUTION**

- Contact the authorized service technician for repair or maintenance of this unit.
- Contact the installer for installation of this unit.
- The air conditioner is not intended for use by young children or infirm persons without supervision.
- Young children should be supervised to ensure that they do not play with the air conditioner.
- If the power cord needs to be replaced, please contact our consumer service and look for an authorized technician.
- Electrical installation must be performed in accordance to national regulation standards by qualified personnel only.

# Safety Precautions

To prevent injury to the user or other people and property damage, the instructions shown here must be followed. Incorrect operation due to ignoring of instructions may cause harm or damage. The level of risk is shown by the following indications.



This symbol indicates the possibility of death or serious injury.



This symbol indicates the possibility of injury or damage to property.



This symbol shows that this appliance uses a flammable refrigerant. If the refrigerant is leaked and exposed to an external ignition source, there is a risk of fire.



This symbol shows that the operation manual should be read carefully.



This symbol shows that a service personnel should be handling this equipment with reference to the installation manual.



This symbol shows that information is available such as the operating manual or installation manual.



## WARNING

- Plug in power cord plug properly. Otherwise, it may cause electric shock or fire due to excess heat generation.
- Do not modify power cord length or share the outlet with other appliances as it may cause electric shock or fire due to overheating.
- Always ensure effective grounding. Incorrect grounding may cause electric shock.
- Unplug the unit if you notice unusual sounds or smells, or smoke comes from it. A damaged product may cause fire and electric shock.
- Keep firearms away from the unit.
- Ventilate room before operating the air conditioner if there is a gas leakage from another appliance.
- Do not operate or stop the unit by inserting or pulling out the power cord plug.
- Do not operate with wet hands or in very humid environments. It may cause electric shock.
- Do not allow water to come into contact with any electric parts. It may cause failure or electric shock.
- Do not use the socket if it is loose or damaged. It may cause fire and electric shock.
- Do not place the power cord close to heating appliances. It may cause fire and electric shock.
- Do not disassemble or modify unit. It may cause failure and electric shock.

**WARNING**

- Do not damage or use an alternate power cord.  
It may cause fire and electric shock.  
If the power cord is damaged, it must be replaced by the manufacturer or an authorized service center or a similarly qualified person in order to avoid a hazard.
- Do not direct airflow straight into persons to avoid possible health hazard.
- Always install a circuit breaker and a dedicated power circuit.  
Incorrect installation may cause fire and electric shock.
- Do not open the unit during operation.  
It may cause electric shock.
- Do not use the power cord near flammable gas or combustibles, such as gasoline, benzene, thinner, etc.  
It may cause an explosion or fire.

**CAUTION**

- When the air filter is to be removed, do not touch the metal parts of the unit.  
It may cause injury.
- When the unit needs cleaning, switch off, and turn off the circuit breaker.  
Do not clean unit when power is on as it may cause fire, electric shock or injury.
- Stop operation and close the window during a in storm or hurricane.  
Operation with windows open may cause water leakage into the room.
- Do not place obstacles around air inlets or inside of air outlet.  
It may cause failure or accident.
- Do not use detergents that contain wax or thinners as it may damage the product.  
Clean with a soft cloth only.
- Use caution when unpacking and installing. Sharp edges could cause injury.
- Do not clean the air conditioner with water.  
Water may enter the unit and degrade the insulation which could lead to electric shock.
- Do not put a pet or house plant where it will be exposed to direct air flow.  
This could injure the pet or harm the plant.
- Hold the plug by the head of the power plug when taking it out.  
Otherwise, it may cause electric shock and damage.
- Ensure that the installation is properly secured to prevent the product from potentially falling.
- Do not place heavy objects on the power cord and ensure that the cord is not compressed.  
Otherwise, there is danger of fire or electric shock.
- If water enters the unit, turn off the unit and switch off the circuit breaker. Isolate supply by taking the power-plug out and contact a qualified service technician.
- When used near a stove or other gas burning device, be sure the room is properly ventilated.  
Otherwise an oxygen shortage may occur.

**! CAUTION**

- Do not use for any purpose other than room comfort. Do not use this air conditioner to preserve precision devices, food, pets, plants, and art objects. It may cause deterioration.
- Turn off the main power switch if the unit is not to be used for an extended time.
- Always insert the filters securely. Clean filter once every two weeks. Operation without filters may cause failure.
- Do not drink water drained from the air conditioner.

**⚠ WARNINGS (for using R32 refrigerant only)**

- Do not use any means to accelerate the defrosting process or to clean the unit, other than those recommended by the manufacturer.
- Do not use or store the appliance in spaces with potential ignition sources (for example: open flames, an operating gas appliance or an operating electric heater).
- Do not pierce or burn refrigerant tubing. Be aware that refrigerants may not contain an odor.
- Keep ventilation openings clear of obstruction.
- Store the appliance in a way that will prevent mechanical damage from occurring.
- Store the appliance in a well-ventilated area where the room size corresponds to the room area as specified for operation.
- Any person who is involved with working on or breaking into a refrigerant circuit should hold a current valid certificate from an industry-accredited assessment authority, which authorizes their competence to handle refrigerants safely in accordance with an industry recognized assessment specification.
- Servicing shall only be performed as recommended by the equipment manufacturer. Maintenance and repair requiring the assistance of other skilled personnel shall be carried out under the supervision of the person competent in the use of flammable refrigerants.
- Flammable refrigerant (R32) is used within the air conditioner. When maintaining or disposing of the air conditioner, the refrigerant (R32) shall be recovered properly, do not discharge to air directly.



Caution: Risk of fire/  
flammable materials  
(Required for R32/R290 units only)

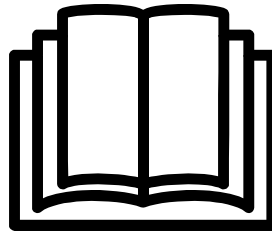

**IMPORTANT NOTE:** Read this manual carefully before installing or operating your new air conditioning unit. Make sure to save this manual for future reference.

**NOTE**

The power supply cord with this air conditioner contains a current detection device designed to reduce the risk of fire.

Please refer to the section Operation of Current Device for details.

In the event that the power supply cord is damaged, it can not be repaired. It must be replaced with a cord from the manufacturer.

**⚠ WARNING - For your safety**

- Do not store or use gasoline or other flammable vapors and liquids in the vicinity of this or any other appliance.
- Avoid fire hazard or electric shock. Do not use an extension cord or an adaptor plug. Do not remove any prongs from the power cord.

**⚠ WARNING - Electrical Information**

The complete electrical rating of your new room air conditioner is stated on the serial plate. Refer to the rating when checking the electrical requirements.

- Be sure the air conditioner is properly grounded. To minimize shock and fire hazards, proper grounding is important. The power cord is equipped with a three-prong grounding plug for protection against shock hazards.
- Your air conditioner must be connected to a properly grounded wall receptacle. If the wall receptacle you intend to use is not adequately grounded or protected by a time delay fuse or circuit breaker, have a qualified electrician install the proper receptacle.
- Ensure the receptacle is accessible after the unit installation.
- Do not run air conditioner without outside protective cover in place. This could result in mechanical damage within the air conditioner.

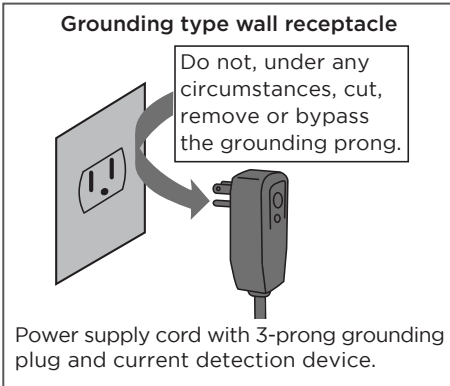

**⚠ WARNING - Prevent Accidents**

To reduce the risk of fire, electrical shock, or injury to persons when using your air conditioner, follow basic precautions, including the following:

- Be sure the electrical service is adequate for the model you have chosen. This information can be found on the serial plate, which is located on the side of the cabinet and behind the grille.
- If the air conditioner is to be installed in a window, you will probably want to clean both sides of the glass first. If the window is a triple-track type with a screen panel included, remove the screen completely before installation.
- Be sure the air conditioner has been securely and correctly installed according to the installation instructions in this manual. Save this manual for possible future use in removing or installing this unit.
- When handling the air conditioner, be careful to avoid cuts from sharp metal fins on front and rear coils.

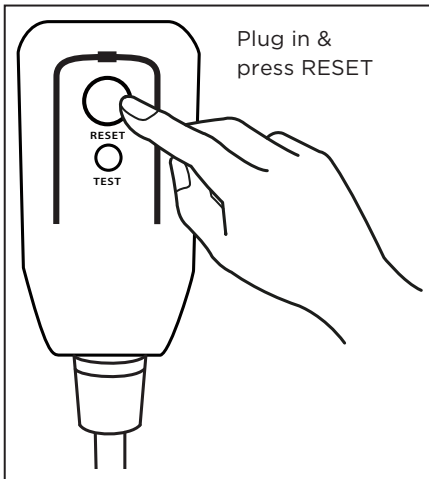
**Operation of Current Device**

The power supply cord contains a current device that senses damage to the power cord. Test your power supply cord as follows:

1. Plug in the air conditioner.
2. The power supply cord will have TWO buttons on the plug head. Press the TEST button. You will notice a click as the RESET button pops out.
3. Press the RESET Button. You will notice a click as the button engages.
4. The power supply cord is now supplying electricity to the unit. (On some products this is also indicated by a light on the plug head.)

**NOTES**

- Do not use this device to turn the unit on or off.
- Always make sure the RESET button is pushed in for correct operation.
- The power supply must be replaced if it fails to reset when either the TEST button is pushed, or it can not be reset. Please contact Customer Service.
- If power supply cord is damaged, it can not be repaired. It **MUST** be replaced with a new cord. Please contact Customer Service.

# Operating Instructions

## Normal Sounds

### MAW05M1

Operating Instructions

#### Sound of Rushing Air

In front of the unit, you may hear the sound of rushing air being moved by the fan.

#### High Pitched Chatter

High efficiency compressors may have a high pitched sound during cooling cycle.

#### Trickling Sound

Droplets of water hitting condenser during normal operation may cause a trickling sound.

#### Gurgle/Hiss

Gurgling or hissing noises may be heard due to refrigerant flowing through evaporator during normal operation.

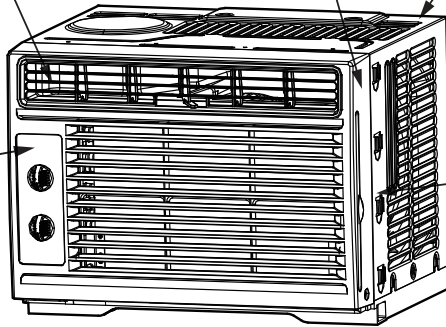

#### Vibration

Unit may vibrate and make noise because of poor wall or window construction or incorrect installation.

### MAW05R1

#### Sound of Rushing Air

In front of the unit, you may hear the sound of rushing air being moved by the fan.

#### High Pitched Chatter

High efficiency compressors may have a high pitched sound during cooling cycle.

#### Trickling Sound

Droplets of water hitting condenser during normal operation may cause a trickling sound.

#### Gurgle/Hiss

Gurgling or hissing noises may be heard due to refrigerant flowing through evaporator during normal operation.

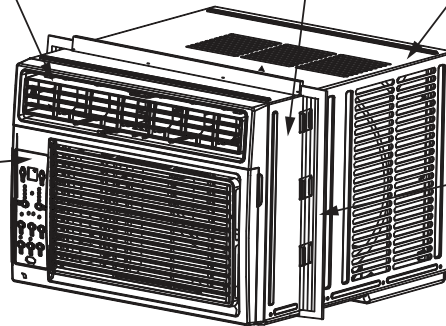

#### Vibration

Unit may vibrate and make noise because of poor wall or window construction or incorrect installation.

## NOTE

All the pictures in this manual are for illustrative purposes only. The actual appearance of the air conditioner you purchased may vary slightly, but its operation and functions will be similar.



# Operating Instructions

## Normal Sounds

### MAW15R1

#### Sound of Rushing Air

In front of the unit, you may hear the sound of rushing air being moved by the fan.

#### Gurgle/Hiss

Gurgling or hissing noises may be heard due to refrigerant flowing through evaporator during normal operation.

#### High Pitched Chatter

High efficiency compressors may have a high pitched sound during cooling cycle.

#### Pinging or Switching

Droplets of water hitting condenser during normal operation may cause pinging or switching.

#### Vibration

Unit may vibrate and make noise because of poor wall or window construction or incorrect installation.

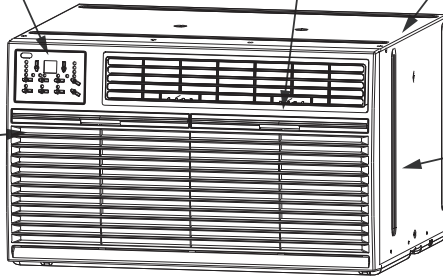

### MAW06R1 / MAW08R1 / MAW10R1 / MAW12R1

#### High Pitched Chatter

Modern compressors may have a high pitched sound during cooling cycle.

#### Sound of Rushing Air

In front of the unit, you may hear the sound of rushing air being moved by the fan.

#### Gurgle/Hiss

Gurgling or hissing noise may be heard due to refrigerant flowing through evaporator during normal operation.

#### Vibration

Unit may vibrate and make noise because of poor wall or window construction or incorrect installation.

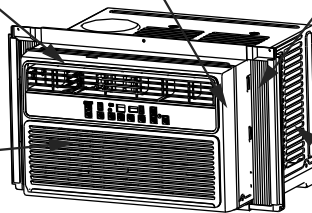

#### Pinging or Switching

Droplets of water hitting condenser during normal operation may cause pinging or swishing.

## NOTE

All the pictures in this manual are for illustrative purposes only. The actual appearance of the air conditioner you purchased may vary slightly, but its operation and functions will be similar.

## Air Conditioner Operation

### WARNING

To reduce the risk of fire, electrical shock, personal injury or property, read the SAFETY PRECAUTIONS before operating this appliance.

### NOTE

The cooling mode has an automatic 3 minutes time delayed start if the unit is turned off and on quickly. This prevents overheating of the compressor and possible tripping.

### TO BEGIN OPERATING THE AIR CONDITIONER, FOLLOW THESE STEPS:

1. Set the lowest number (coldest setting).
2. Set the selector control to the highest COOL setting.
3. Adjust the louver for comfortable air flow (see Air Directional Louvers).
4. Once the room feels colder, adjust the setting you find most comfortable.
5. Make sure that the air flow inside and outside are not obstructed by anything.
6. This air conditioner is designed to be operated under the following conditions:

Cooling Operation	Outdoor temp.: 64-109°F/18-43°C (64-125°F/18-52°C for special tropical models)
	Indoor temp.: 62-90°F/17-32°C
Heating Operation	Outdoor temp.: 23-76°F/-5-24°C
	Indoor temp.: 32-80°F/0-27°C

### NOTES

- The relative humidity of room should be less than 80%. If the unit is used in a condition with a relative humidity over 80%, there will be condensed water on the surface of the unit.
- Performance may be reduced outside of these operating temperatures.

Before you begin, thoroughly familiarize yourself with the control panel as shown below and all its functions, then follow the symbol for the functions you desire. The unit can be controlled by the unit control panel alone or with the remote controller.

## Air Conditioner Features - MAW05M1

### NOTE

The controls featured in this manual are representative of many available models. Your model's features and appearance may vary slightly.

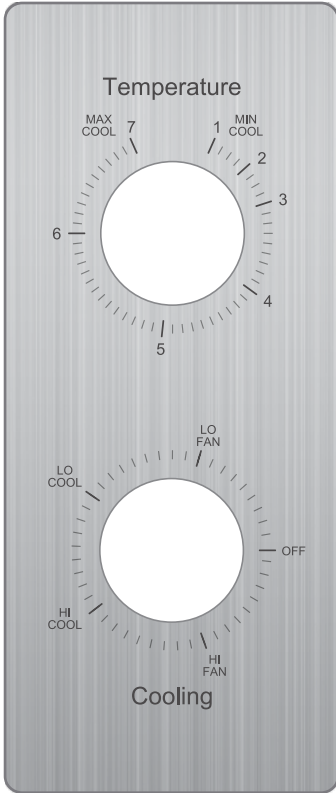

### UNIT CONTROL

### THERMOSTAT

The thermostat is used to set the desired room temperature when the unit is being operated in the COOL MODE.

To set the desired room temperature, rotate the thermostat switch to the desired setting. After the set temperature is achieved the thermostat will automatically start and stop the compressor in order to maintain the desired set temperature.

Rotate the thermostat selector clockwise for higher cool settings. Higher cool settings will provide lower room temperature. Rotate the thermostat selector counter clockwise for lower cool settings. Lower cool settings will provide higher room temperature.

### COOL MODE

The desired cool setting is selected by rotating the knob to the right to the appropriate location.

**High Cool** has maximum cooling effect and airflow.

**Low Cool** has minimum cooling effect and airflow.

### FAN MODE

Rotate the knob to the left to select your choice of fan speeds for air circulation.

### NOTE

When selecting a fan speed, the compressor will not run.

# Air Conditioner Features - MAW05R1

## ELECTRONIC CONTROL OPERATING INSTRUCTIONS

Before you begin, thoroughly familiarize yourself with the control panel as shown below and all its functions, then follow the symbol for the functions you desire. The unit can be controlled by the unit control alone or with the remote controller.

Operating Instructions

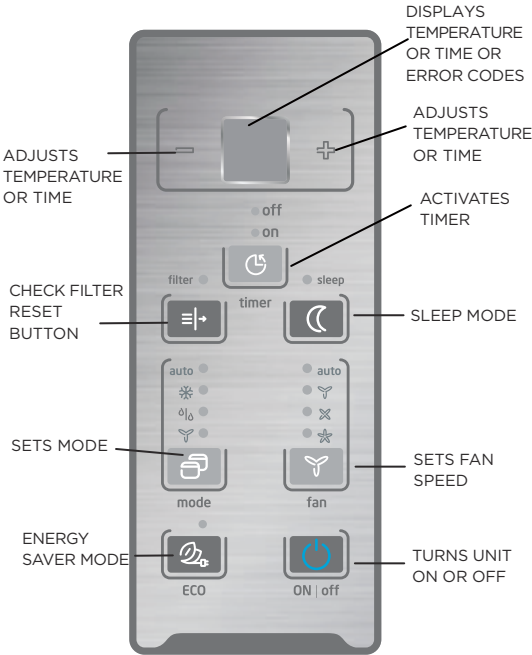

### UNIT CONTROL



#### TO TURN UNIT ON OR OFF:

Press ON/OFF button to turn unit on or off.

#### NOTE

The unit will automatically initiate the Energy Saver function under Cool, Dry, Auto (only Auto-Cooling and Auto-Fan) modes.

#### TO CHANGE TEMPERATURE SETTING:

Press UP () / DOWN () button to change temperature setting.

#### NOTE

Press or hold either UP () / DOWN () button until the desired temperature is seen on the display.

This temperature will be automatically maintained anywhere between 62°F (17°C) and 86°F (30°C). If you want to display the actual room temperature, see To Operate on Fan Only section.

#### TO ADJUST FAN SPEEDS:

Press to select the Fan Speed in four steps-Auto, Low, Med or High. Each time the button is pressed, the fan speed mode is changed. On Dry mode, the fan operates on Low speed automatically.

**SLEEP FEATURE:**

Press  Sleep button to initiate the sleep mode. In this mode the selected temperature will increase by 2°F/1 (or 2)°C 30 minutes after the mode is selected. The temperature will then increase by another 2°F/1 (or 2)°C after an additional 30 minutes. This new temperature will be maintained for 6 hours before it returns to the originally selected temperature. This ends the Sleep mode and the unit will continue to operate as originally programmed. The Sleep mode program can be cancelled at any time during operation by pressing the Sleep button again.

**CHECK FILTER FEATURE:**

Press  Check filter button to initiate this feature. This feature is a reminder to clean the Air Filter for more efficient operation. The light will illuminate after 250 hours of operation. To reset after cleaning the filter, press the Check Filter button and the light will go off.

**ENERGY SAVER FEATURE:**

Press  Energy Saver button to initiate this function. This function is available on COOL, DRY, AUTO (only AUTO-COOLING and AUTO-FAN) modes. The fan will continue to run for 3 minutes after the compressor shuts off. The fan then cycles on for 2 minutes at 10 minute intervals until the room temperature is above the set temperature, at which time the compressor turns back on and Cooling resumes.

**TO SELECT THE OPERATING MODE:**

To choose operating mode, press  Mode button. Each time you press the button the unit cycles through the modes, Auto, Cool, Dry, and Fan. The adjacent indicator light will remain on once the mode is selected.

The unit will automatically initiate the Energy Saver function under Cool, Dry, Auto (only Auto-Cooling and Auto-Fan) modes.

**To operate on Auto feature:**

- When you set the air conditioner to AUTO mode, it will automatically select cooling or fan only operation depending on what temperature you have selected and the current room temperature.
- The air conditioner will control room temperature automatically according to the temperature you've set.
- In this mode, the fan speed cannot be adjusted, as it's automatically controlled according to the temperature setting and room temperature.



**To operate on Fan Only:**

- Use this function only when cooling is not desired, such as for room air circulation or to exhaust stale air (on some models). (Remember to open the vent during this function, but keep it closed during cooling for maximum cooling efficiency.) You can choose any fan speed you prefer.
- During this function, the display will show the actual room temperature, not the set temperature as in the cooling mode.
- In Fan Only mode, the temperature is not adjusted.

**To operate on Dry mode:**

In this mode, the air conditioner will generally function as a dehumidifier. Since the conditioned space is a closed or sealed area, some degree of cooling will occur.

**TIMER: AUTO START/STOP FEATURE:**

- When the unit is on or off, first press  the Timer button. The TIMER ON indicator light illuminates indicating the Auto Start program has initiated.
- When the time of TIMER ON is displayed, press the Timer button again. The TIMER OFF indicator light illuminates. It indicates the Auto Stop program has initiated.
- Press or hold the UP (  ) or DOWN (  ) button to change the Auto time by 0.5 hour increments, up to 10 hours, then at 1 hour increments up to 24 hours. The control will count down the time remaining until start.
- The selected time will register in 5 seconds, and the system will automatically revert back to display the previous temperature setting or room temperature when the unit is on. (when the unit is off, there is no display.)
- Turning the unit ON or OFF at any time or adjusting the timer setting to 0.0 will cancel the Auto Start/Stop timed program.
- If setting ON 0.5 and OFF 1 at the same time, the unit will be activated in 0.5 hour, operates for 0.5 hour and then stops.

**Displays:**

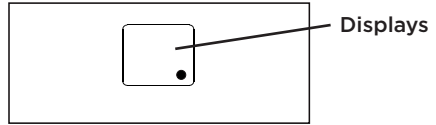

Shows the set temperature in “°C” or “°F” and the Auto-timer settings. While on Fan Only mode, it shows the room temperature.

**Error codes:**

**AS** - Room temperature sensor error -  
 - Unplug the unit and plug it back in. If error repeats, call for service.  
 NOTE: In Fan Only mode, it will display “LO” or “HI.”

**ES** - Evaporator temperature sensor error  
 - Unplug the unit and plug it back in. If error repeats, call for service.

**NOTE**

If the unit shuts off unexpectedly due to the power outage, it will restart with the previous function setting automatically when the power resumes.

## Air Conditioner Features - MAW06R1 to MWA12R1

### NOTES

- The relative humidity of room should be less than 80%. If the unit is used in a condition with a relative humidity over 80%, there will be condensed water on the surface of the unit.
- Performance may be reduced outside of these operating temperatures.

### ELECTRONIC CONTROL OPERATING INSTRUCTIONS

Before you begin, thoroughly familiarize yourself with the control panel as shown below and all its functions, then follow the symbol for the functions you desire. The unit can be controlled by the unit control alone or with the remote controller.

### Key Pad Features

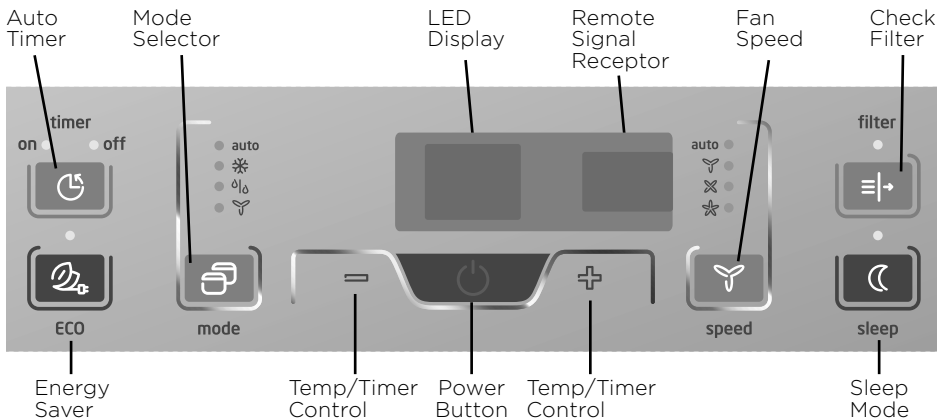

#### (ON/OFF) Button

The unit will initiate automatically the Energy saver function under Cool, Dry, Auto (only Auto-Cooling and Auto-Fan) modes.

#### NOTE

If the unit turns off unexpectedly due to a power outage, it will restart with its previously set functions when the power resumes.

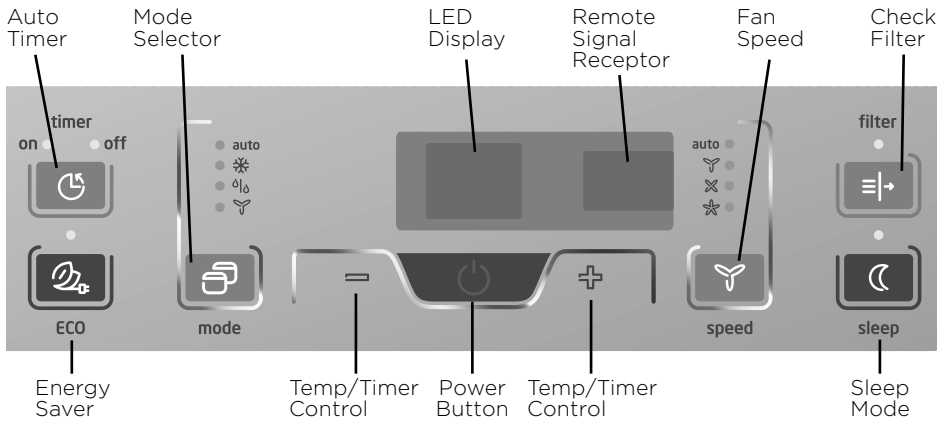

### (UP/DOWN) Button

Press or hold either left (-) or right (+) button until the desired temperature is seen on the display. This temperature will be automatically maintained at the set temperature, between 62°F (17°C) and 86°F (30°C). If you want the display to read the actual room temperature, see "To Operate on Fan Only" section.

### (MODE) Button

- To choose operating mode, press Mode button. Each time you press the button, a mode is selected in a sequence that goes from Auto, Cool, Dry and Fan. The indicator light beside will be illuminated and remains on once the mode is selected.
- The unit will initiate automatically the Energy Saver function under Cool, Dry, Auto (only Auto-Cooling and Auto-Fan) modes.

### Operating on AUTO mode:

- When you set the air conditioner in AUTO mode, it will automatically select cooling, heating (selected models only) or fan only operation depending on what temperature you have selected and the room temperature.
- The air conditioner will control room temperature automatically to hit the temperature set point you choose.
- In this mode, the fan speed cannot be adjusted, it starts automatically at a speed according to the room temperature.

### Operating on FAN mode:

- Use this function only when cooling is not desired, such as for room air circulation or to exhaust stale air (on some models). (Remember to open the vent during this function, but keep it closed during cooling for maximum cooling efficiency.) You can choose any fan speed you prefer.
- During this function, the display will show the actual room temperature, not the set temperature as in the cooling mode.
- In Fan only mode, the temperature can not be adjusted.

### Operating on DRY mode:

In this mode, the air conditioner will operate in the form of a dehumidifier. Since the conditioned space is a closed or sealed area, some degree of cooling will continue.

### (FAN SPEED) Button

Used to select the Fan Speed in four steps - Auto, Low, Med or High. Each time the button is pressed, the fan speed mode is shifted. On Dry mode, the fan speed is controlled at low automatically.

### (ENERGY SAVER) Button

This function is available on COOL, DRY, AUTO (only AUTO-COOL and AUTO-FAN) modes. The fan will continue to run for 3 minutes after the compressor shuts off. The fan then cycles on for 2 minutes at 10 minute intervals until the room temperature is above the set temperature,



at which time the compressor turns back on and Cooling Starts.

### (SLEEP) Button

In this mode the selected temperature will increase by 2°F/1°C 30 minutes after the mode is selected. The temperature will then increase by another 2°F/1°C after an additional 30 minutes.

This new temperature will be maintained for 6 hours before it returns to the originally selected temperature.

This ends the Sleep mode and the unit will continue to operate as originally programmed. The Sleep mode program can be cancelled at any time during operation by again pressing the Sleep button.

### (TIMER) Button

- When the unit is on or off, first press Timer button, the TIMER ON indicator light illuminates. It indicates the Auto Start program is initiated.
- When the time of TIMER ON is displayed, press the Timer button again, the TIMER OFF indicator light illuminates. It indicates the Auto Stop program is initiated.
- Press or hold either left (←) or right (→) button to change the Auto time by 0.5 hour increments, up to 10 hours, then at 1 hour increments up to 24 hours. The control will count down the time remaining until start.
- The selected time will register in 5 seconds, and the system will automatically

revert back to display the previous temperature setting or room temperature when the unit is on. (when the unit is off, there is no display.)

- Turning the unit ON or OFF at any time or adjusting the timer setting to 0.0 will cancel the Auto Start/Stop timed program.

### (CHECK FILTER) Button

This feature is a reminder to clean the Air Filter for more efficient operation. The LED (light) will illuminate after 250 hours of operation. To reset after cleaning the filter, press the Check Filter button and the light will go off.

LED  
Display



### LED Display:



Shows the set temperature in “°C” or “°F” and the Auto-timer settings. While on Fan only mode, it shows the room temperature.

### Error codes:

- AS** - Room temperature sensor error - Unplug the unit and plug it back in. If error repeats, call for service.  
NOTE: In Fan only mode, it will display “LO” or “HI”.
- - Evaporator temperature sensor error - Unplug the unit and plug it back in. If error repeats, call for service.  
NOTE: “●” is displayed as shown in the left picture.
- HS** - Electric heating sensor error - Unplug the unit and plug it back in. If error repeats, call for service.

## Additional Information

Now that you understand the operating procedure, here are more features in your control that you should become familiar with.

- The Cool circuit has an automatic 3 minute time delayed start if the unit is turned off and on quickly. This prevents overheating of the compressor and possible circuit breaker tripping. The fan will continue to run during this time.
- The control can display temperature in Fahrenheit or Celsius. To convert from one to the other, press and hold the UP (  )/DOWN (  ) Temp/Timer buttons at the same time, for 3 seconds.

### FRESH AIR VENT CONTROL (FOR 5000 BTU/H TO 15000 BTU/H)

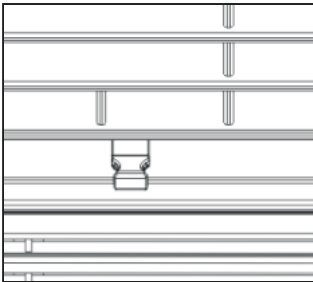

Fig. A (VENT CLOSED)

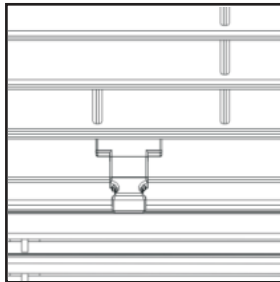

Fig. B (VENT OPEN)

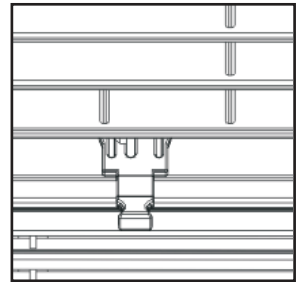
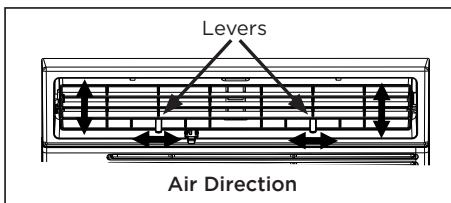

Fig. C (VENT & EXHAUST OPEN)

The Fresh Air Vent allows the air conditioner to:

1. Recirculate inside air - Vent Closed (See Fig. A)
2. Draw fresh air into the room - Vent Open (See Fig. B)
3. Exchange air from the room and draw fresh air into the room - Vent and Exhaust Open (See Fig. C).

### AIR DIRECTIONAL LOUVERS



The louvers will allow you to direct the air flow up or down Down (on some models) and left or right throughout the room as needed. Pivot horizontal louvers until the desired up/down direction is obtained.

Move the levers from side to side until the desired left/right direction is obtained.

# Installation Instructions

## **⚠ WARNING - Before You Begin**

Read these instructions completely and carefully.

- **IMPORTANT** - Save these instructions for local inspector's use.
- **IMPORTANT** - Observe all governing codes and ordinances.
- **Note to Installer** - Be sure to leave these instructions with the consumer.
- **Note to Consumer** - Keep these instructions for future reference.
- **Skill level** - Installation of this appliance requires basic mechanical skills.
- **Completion time** - Approximately 1 hour. We recommend that two people install this product.

Proper installation is the responsibility of the installer.

Product failure due to improper installation is not covered under the Warranty.

You **MUST** use all supplied parts and use proper installation procedures as described in these instructions when installing this air conditioner.

Do not, under any circumstances, cut or remove the third (ground) prong from the power cord.

Do not change the plug on the power cord of the air conditioner.

Aluminum house wiring may present special problems - consult a qualified electrician.

When handling unit, be careful to avoid cuts from sharp metal edges and aluminum fins on front and rear coils.

Your air conditioner is designed to install in standard double hung windows with opening widths of 23 to 36 inches (584mm to 914mm) (See Fig. D).

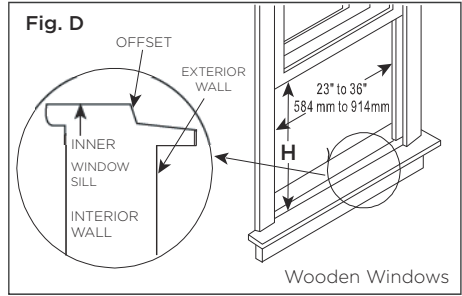
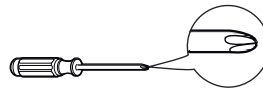

Table 1

Model	5000 BTU/h	6000-8000 BTU/h	10000-12000 BTU/h	15000 BTU/h
H	13" (330mm)	14" (356mm)	15-1/2" (394mm)	18-1/2" (394mm)

## Tools You Will Need



Phillips Screwdriver



Level

## Tools You May Use



Flathead Screwdriver



Pencil

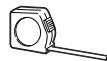

Ruler or tape measure



Scissors or knife

## NOTE

Save carton and these Installation Instructions for future reference. The carton is the best way to store unit during winter, or when not in use.

### 1. PREPARE THE WINDOW

Lower sash must open sufficiently to allow a clear vertical opening (see dimension H in Table 1). Side louvers and the rear of the AC must have clear air space to allow enough airflow through the condenser for heat removal. The rear of the unit must be outdoors, not inside a building or garage.

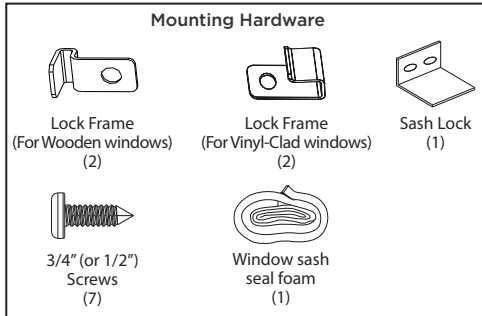

### ! CAUTION

When handling unit, be careful to avoid cuts from sharp metal edges and aluminum fins on front and rear coils.

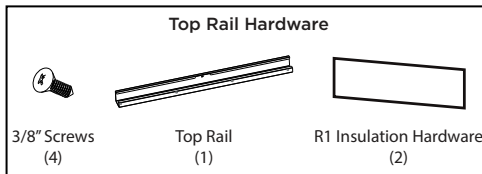

### 2. PREPARE AIR CONDITIONER

Before installing the unit, the top rail must be assembled on the unit for models with a capacity of less than 10,000Btu/h.

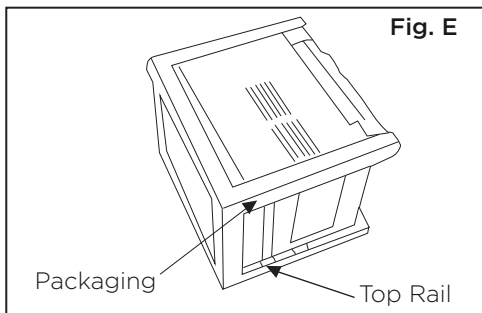

A: Remove the air conditioner from the carton and place on a flat surface.

B: Remove top rail from the packaging material as shown in Fig. E.

C: Align the hole in the top rail with those in the top of the unit as shown in Fig. F.

D: Secure the top rail to the unit with the 3/8" (9.5mm) screws as shown in Fig. G.

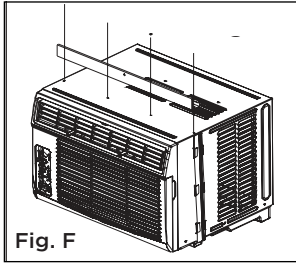

Fig. F

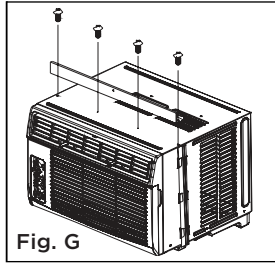

Fig. G

#### NOTE

For safety reasons, all four (4) screws **MUST** be securely fastened.

### 3. INSTALL THE ACCORDION PANELS

#### NOTE

Top rail and side panels at each side are offset to provide the proper pitch to the rear of 5/16" (8mm). This is necessary for proper condensed water management and drainage. If you are not using the side panels for any reason, this pitch to the rear must be maintained.

1. Place unit on floor, a bench or a table. There is a left and right side accordion panel; be sure to use the proper panel for each side. When installed, the flange for securing the panel in place to the window sill will be facing into the room.
  - A. Hold the side panel in one hand and gently pull back the center to free the open end. See Fig. 1.
  - B. Slide the free and "I" section of the panel directly into the cabinet as shown in Fig. 2. Slide the panel down. Be sure to leave enough space to slip the top and bottom of the frame into the rails on the cabinet.
  - C. Once the panel has been installed on the side of the cabinet, make sure it sits securely inside the frame channel by making slight adjustments. Slide the top and bottom ends of the frame into the top and bottom rails of the cabinet. Fig. 3.

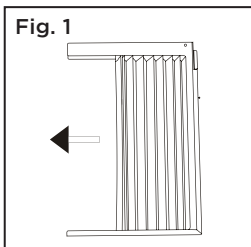

Fig. 1

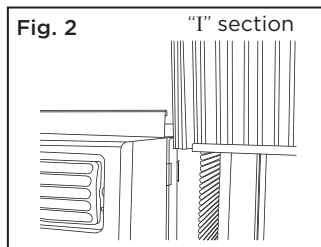

Fig. 2

"I" section

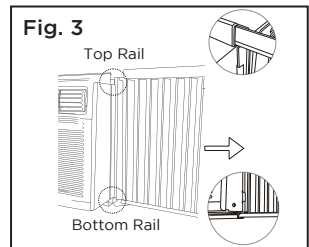

Fig. 3

Top Rail

Bottom Rail

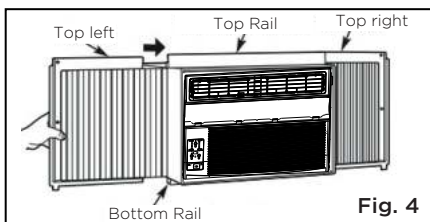
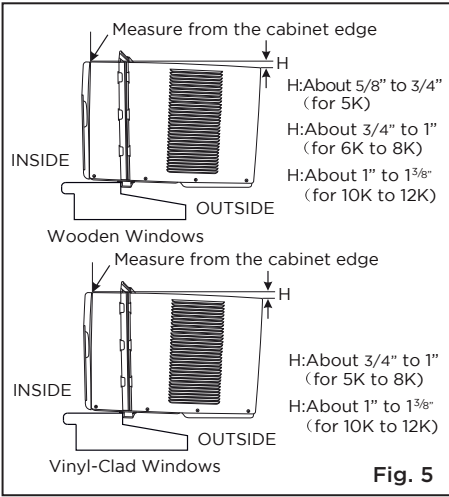

Fig. 4

- D. Slide the panel all the way in and repeat on the other side.

#### NOTE

If storm window blocks AC, see Fig. 11.



- While keeping a firm grip on the air conditioner, carefully place the unit into the window opening so the bottom of the air conditioner frame is against the window sill (Fig. 5). Carefully close the window behind the top rail of the unit.

**NOTE**

Check that air conditioner is tilted back per dimension H (Fig. 5) (tilted about 3° to 4° downward to the outside). After proper installation, condensate should not drain from the overflow drain hole during normal use. Adjust the slope if otherwise.

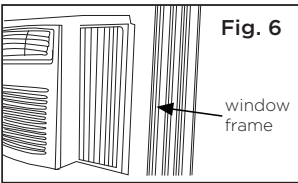

- Extend the side panels out against the window frame (Fig. 6).

**4. INSTALL SUPPORT BRACKET**

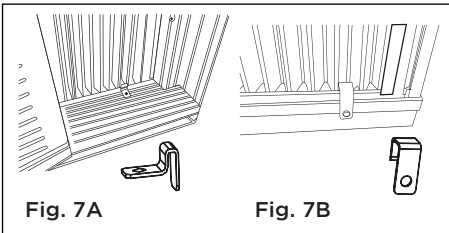

- Place the frame lock between the frame extensions and the window sill as shown (Fig. 7A for Wooden windows), (Fig. 7B for Vinyl-Clad windows).

Drive 3/4" (19 mm) or 1/2" (12.7 mm) locking screws through the frame lock and into the sill.

**NOTE:** To prevent window sill from splitting, drill 1/8" (3 mm) pilot holes before driving screws.

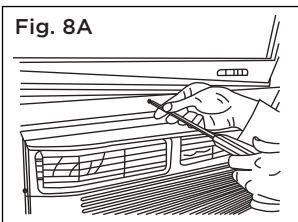

- For wooden windows:

Drive 1/2" (12.7 mm) locking screws through the frame lock and into the sill (Fig. 8A).

**NOTE:** To prevent window sill from splitting, drill 1/8" (3mm) pilot holes before driving screws. Drive 1/2" (12.7mm) locking screws through frame holes into window sash (Fig. 8B/8C).

**MAW05M**

**MAW05R1 to MAW12R1**

B2: For Vinyl-Clad windows:

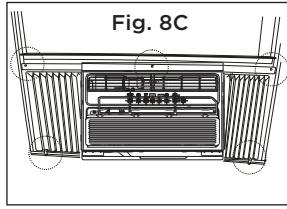
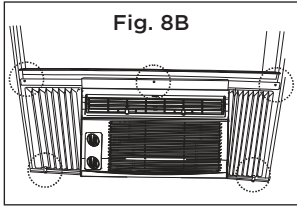

Drive 1/2" (12.7 mm) locking screws through the frame lock and into the window sash (Fig. 8B).

NOTE: Before driving the screws, use a drill to drill 5 holes through the holes in the frame lock and frame extensions into the window sash as shown (Fig. 8B/8C).

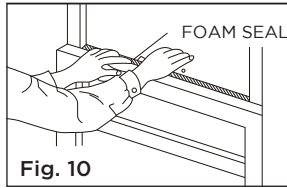

- C. To secure lower sash in place, attach right angle sash lock with 3/4" (19 mm) or 1/2" (12.7 mm) screw as shown (Fig. 9).
- D. Cut Window sash seal foam and insert it in the space between the upper and lower sashes (Fig. 10).

**If AC is Blocked by Storm Window**

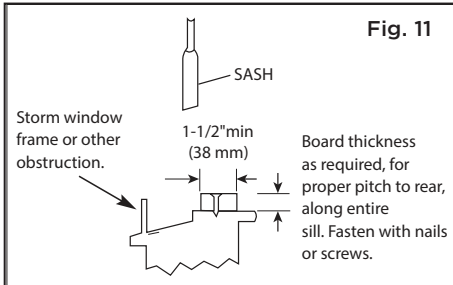

Add wood as shown in Fig. 11, or remove storm window before air conditioner is installed.

If storm window frame must remain, be sure the drain holes or slots are not caulked or painted shut. Accumulated rain water or condensation must be allowed to drain out.

**Removing AC From Window**

- Turn AC off, and disconnect power cord.
- Remove sash seal from between windows, and unscrew safety lock.
- Remove screws installed through frame and frame lock.
- Close (slide) side panels into frame.
- Keeping a firm grip on air conditioner, raise sash and carefully remove.
- Be careful not to spill any standing water while lifting unit from window. Store parts WITH air conditioner.

# Care and Cleaning

## ! CAUTION

Clean your air conditioner occasionally to keep it looking new. Be sure to unplug the unit before cleaning to prevent shock or fire hazards.

## Air Filter Cleaning

The air filter should be checked at least once a month to see if cleaning is necessary. Trapped particles in the filter can build up and cause an accumulation of frost on the cooling coils.

- Push the vent handle to the closed position (where applicable). Open the front panel.
- Take the filter by the center and pull up and out.
- Wash the filter using liquid dishwashing detergent and warm water. Rinse filter thoroughly.
- Gently shake excess water from the filter. Be sure the filter is thoroughly dry before replacing.
- You may also vacuum the filter clean rather than washing.

MAW05M1

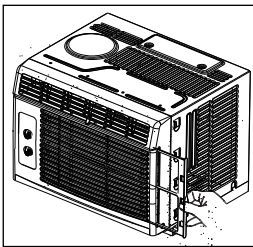

MAW05R1

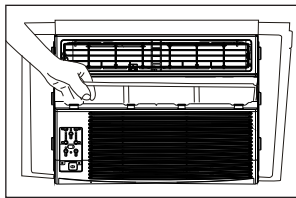

MAW06R1 to MAW12R1

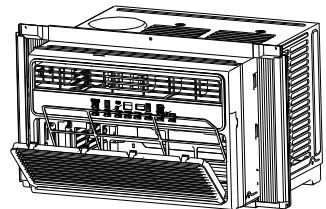

## NOTE

Never use hot water over 104°F (40°C) to clean the air filter. Never attempt to operate the unit without the air filter.

## Cabinet Cleaning

- Be sure to unplug the air conditioner to prevent shock or fire hazard. The cabinet and front may be dusted with an oil-free cloth or washed with a cloth dampened in a solution of warm water and mild liquid dishwashing detergent. Rinse thoroughly and wipe dry.
- Never use harsh cleansers, wax or polish on the cabinet front.
- Be sure to wring excess water from the cloth before wiping around the controls. Excess water in or around the controls may cause damage to the air conditioner.
- Plug in air conditioner.

## Winter Storage

If you plan to store the air conditioner during the winter, remove it carefully from the window according to the installation instructions. Cover it with plastic or return it to the original carton.



# Troubleshooting Tips

Before calling for service, review this list. It may save you time and expense. This list includes common occurrences that are not the result of defective workmanship or materials in this appliance.

Problem	Solution
Air conditioner does not start	Wall plug disconnected. Push plug firmly into wall outlet.
	House fuse blown or circuit breaker tripped. Replace fuse with time delay type or reset circuit breaker.
	Plug current device tripped. Press the RESET button.
	Power is Off. Turn Power On and set to desired setting.
	Unit turned off and then on quickly. Turn unit off and wait 3 minutes before restarting.
Air from unit does not feel cold enough	Room temperature below 62°F (17°C). Cooling may not occur until room temperature rises above 62°F (17°C).
	Temperature sensing element touching cold coil, located behind air filter. Straighten tube away from coil.
	Reset to a lower temperature.
	Compressor shut-off by changing modes. Wait approximately 3 minutes and listen for compressor to restart when set in the COOL mode.
Air conditioner cooling, but room is too warm- ice forming on cooling coil behind decorative front.	Outdoor temperature below 64°F (18°C). To defrost the coil, set to FAN ONLY mode.
	Air filter may be dirty. Clean filter. Refer to Care and Cleaning section. To defrost, set to FAN ONLY mode.
	Thermostat set too cold for night-time cooling. To defrost the coil, set to FAN ONLY mode. Then, set temperature to a higher setting.
Air conditioner cooling, but room is too warm- NO ice forming on cooling coil behind decorative front	Air filter may be dirty. Clean filter. Refer to Care and Cleaning section. To defrost, set to FAN ONLY mode.
	Temperature is set too high, set temperature to a lower setting.
	Air directional louvers positioned improperly. Position louvers for better air distribution.
	Front of unit is blocked by drapes, blinds, furniture, etc. - restricts air distribution. Clear obstruction in front of unit.
	Doors, windows, registers, etc. open - cold air escapes. Close doors, windows, registers.
	Unit recently turned on in hot room. Allow additional time to remove "stored heat" from walls, ceiling, floor and furniture.
Air conditioner turns on and off rapidly	Dirty air filter- air restricted. Clean air filter.
	Outside temperature extremely hot. Set FAN speed to a higher setting to bring air past cooling coils more frequently.

Problem	Solution
Noise when unit is cooling	Air movement sound. This is normal. If too loud, set to a slower FAN setting.
	Window vibration - poor installation. Refer to installation instructions or check with installer.
Water dripping INSIDE when unit is cooling	Improper installation. Tilt air conditioner slightly to the outside to allow water drainage. Refer to installation instructions - check with installer.
Water dripping OUTSIDE when unit is cooling	Unit removing large quantity of moisture from humid room. This is normal during excessively humid days.
Remote sensing deactivating prematurely (some models)	Remote control not located within range. Place remote control within 20 feet & 180°, radius of the front of the unit.
	Remote control signal obstructed. Remove obstruction.
Room too cold	Temperature setting too low. Increase temperature setting.

If your product displays error code as follows, please call our toll free service number: 1-866-646-4332 for assistance.

# Remote Control Instructions

## Handling the Remote Controller

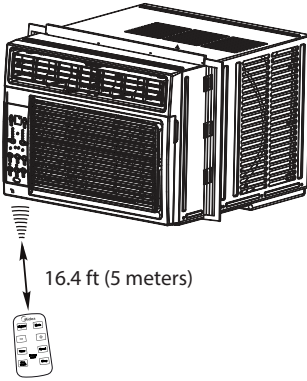

### LOCATION OF THE REMOTE CONTROLLER

Use the remote controller within a distance of 16.4 ft (5 meters) from the air conditioner, pointing it towards the receiver. Reception is confirmed by a beep.

### ! CAUTION

- The air conditioner will not operate if curtains, doors or other materials block the signals from the remote controller to the unit.
- Prevent any liquid from spilling onto the remote controller. Do not expose the remote controller to direct sunlight or heat.
- If the infrared signal receiver on the indoor unit is exposed to direct sunlight, the air conditioner may not function properly. Use curtains to prevent the sunlight from falling on the receiver.
- If other electrical appliances react to the remote controller, either move these appliances or consult your local dealer.

## Replacing the Battery

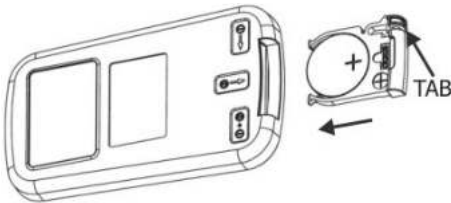

Turn Remote Control upside down. Squeeze tab and pull to remove battery tray. Place battery in tray with POSITIVE (+) side facing up, according to picture. Re-insert battery tray.

### ! WARNING

- Battery must be disposed of properly. Do not short circuit or dispose of in a fire.
- Keep batteries out of the reach of children.
- Do not ingest.
- Non-rechargeable batteries are not to be recharged.
- Exhausted batteries are to be removed from the product.

## Remote Control Specifications

Model	RG15B1/E
Rated Voltage	3.0V (Lithium battery CR2025)
Lowest Voltage of CPU Emitting Signal	2.4 V
Signal Receiving Range	16.4 ft (5 m)
Environment	-5 °C - 60 °C (23°F - 140°F)

### NOTES

- Button design is based on typical model and may vary slightly from the actual one you purchased.
- All the functions described are accomplished by the unit. If the unit is without a feature, the unit will not respond if the corresponding button on the remote is pressed.
- When there are significant differences between features or operation implied by the remote control illustration and the actual functions described in the USER'S MANUAL, the descriptions in the USER'S MANUAL shall prevail.

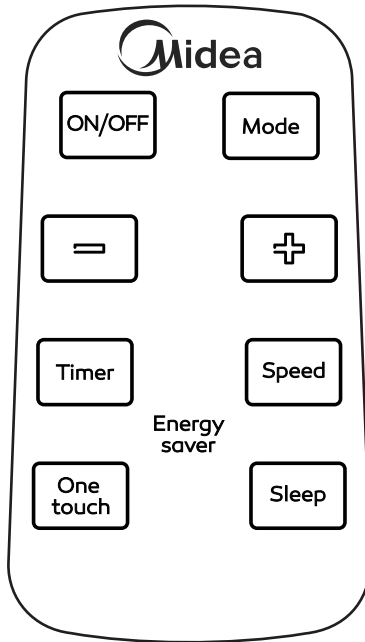

## Function Buttons

### ON/OFF Button

Operation starts when this button is pressed and stops when the button is pressed again.

*NOTE: If the unit has ENERGY SAVER function, it will initiate automatically the Energy Saver function under Cool, Dry, and Auto (only Auto-Cooling and Auto-Fan) modes.*

### TEMP DOWN Button

Press this button to decrease the indoor temperature setting.

### TIMER Button

Press this button to activate the "Auto Start" or "Auto Stop" program.

### ONE TOUCH Button

Push this button and the system will automatically shift to COOL operation with auto fan speed and a temperature setting of 26°C/80°F. Any timer setting program will be cancelled.

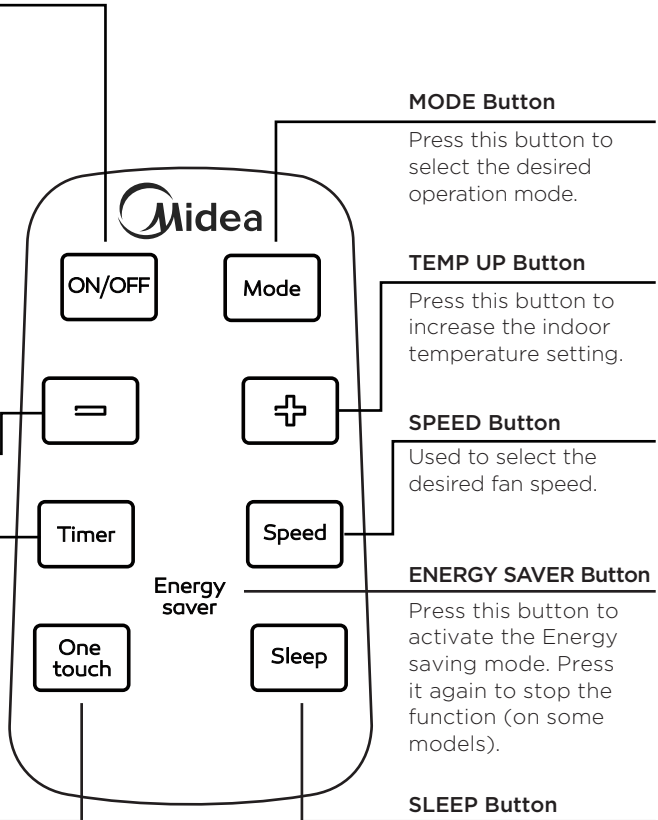

## How to Use the Buttons

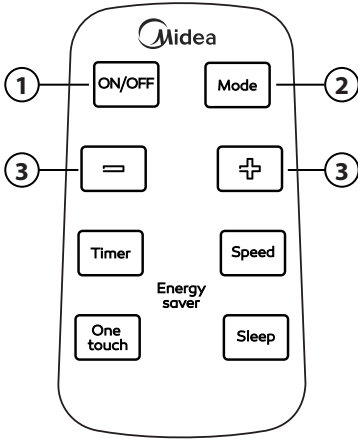

### AUTO OPERATION

Ensure the unit is plugged in and power is available.

1. Press the ON/OFF button to start the air conditioner.
2. Press the MODE button to select Auto.
3. Press the TEMP UP (+)/DOWN (-) button to set the desired temperature.

### NOTES

1. In the Auto mode, the air conditioner can logically choose the mode (Cooling or Fan) and by sensing the difference between the actual ambient room temperature and the set temperature on the remote controller.
2. In Auto mode, you cannot adjust the fan speed. As it is controlled automatically.
3. If the Auto mode is not comfortable for you, the desired mode can be selected manually.

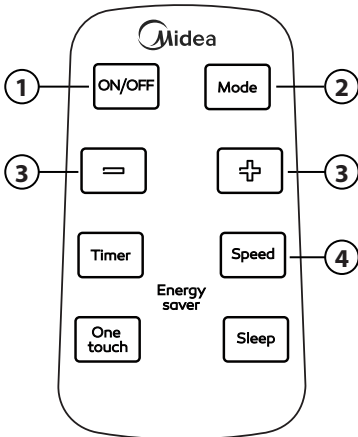

### COOLING / FAN OPERATION

Ensure the unit is plugged in and power is available.

1. Press the ON/OFF button to start the air conditioner.
2. Press the MODE button to select Cool or Fan mode.
3. Press the TEMP UP (+)/DOWN (-) button to set the desired temperature.
4. Press the SPEED button to select the fan speed.

### NOTES

Temperature cannot be changed in Fan mode.

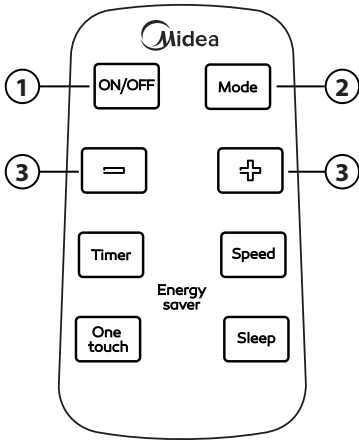

## DEHUMIDIFYING OPERATION

Ensure the unit is plugged in and power is available.

1. Press the ON/OFF button to start the air conditioner.
2. Press the MODE button to select Dry.
3. Press the TEMP UP (+)/DOWN (-) button to set the desired temperature.

### NOTES

In the Dehumidifying mode, you cannot adjust the fan speed, as it is controlled automatically.

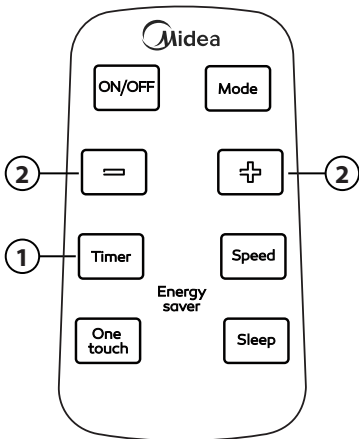

## TIMER OPERATION

Press the TIMER button to initiate the Auto-start and Auto-stop setting program of the unit.

### To set the Auto-start/stop time.

1. Press the TIMER button, when the TIMER ON indicator is displayed on the LED window of the air conditioner, it indicates the Auto Start setting program is initiated. When the TIMER OFF indicator is displayed on the LED window of the air conditioner, it indicates the Auto Stop setting program is initiated.
2. Press or hold the TEMP UP (+)/DOWN (-) to change the Auto time. The control will count down the time remaining until start/stop.
3. The selected time will register in 5 seconds and the air conditioner will automatically revert back to display the previous temperature setting.
4. Turning the unit ON or OFF at any time will cancel the Auto Start/stop function.

### NOTES

To cancel the TIMER setting, push the TIMER button and press or hold the TEMP UP (+)/DOWN (-) until 0 hour is displayed on the LCD window of the air conditioner.

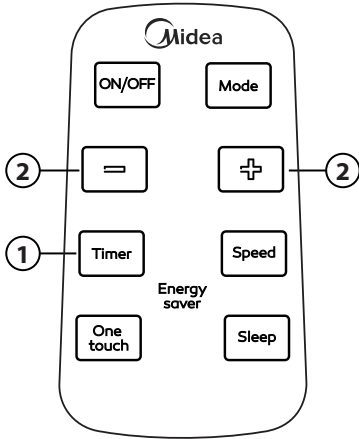

## COMBINED TIMER

(Setting both ON and OFF timers simultaneously)

### AUTO STOP > AUTO START

#### (On > Stop > Start operation)

This feature is useful when you want to stop the air conditioner after you go to bed, and start it again in the morning when you wake up or when you return home.

#### Example:

To stop the air conditioner 2 hours after setting and start it again 10 hours after setting.

1. Press the TIMER button until the TIMER OFF indicator is displayed on the LED display of the air conditioner.
2. Use the TEMP UP (+)/DOWN (-) button to display "2.0" on the LED display of the air conditioner.
3. Press the TIMER button again to display the TIMER OFF on the LED display of the unit.
4. Use the TEMP UP (+)/DOWN (-) button to display "10" on the LED display of the unit.
5. Wait for 5 seconds until the previous display appears in LED window.

### AUTO START > AUTO STOP

#### (Off > Start > Stop operation)

This feature is useful when you want to start the air conditioner before you wake up and stop it after you leave the house.

#### Example:

To start the air conditioner 5 hours after setting, and stop it 8 hours after setting.

1. Press the TIMER button until the TIMER ON indicator is displayed on the LED display of the air conditioner.
2. Use the TEMP UP (+)/DOWN (-) button to display "5.0" on the LED display of the air conditioner.
3. Press the TIMER button again to display the TIMER OFF on the LED display of the unit.
4. Use the TEMP UP (+)/DOWN (-) button to display "8.0" on the LED display of the unit.
5. Wait for 5 seconds until the previous display appears in LED window.









